

Pilot Test Laser Results
With many thanks to all involved
Steve Hutchins, Marta Csatari, Ian Ross

The feasibility study ended in 2002, and included topics:

- Basic design features
- Pumping Schemes
- Amplifier Simulations
- Thermal Effects
- System Staging
- Non-linear optics
- Stability
- Failure modes/protection
- Oscillators
- Timing

Hardware was produced and tested at RAL, but under conditions that are different to those of CTF3. (cw injection...)

The Pilot Test was planned in order to demonstrate a small scale injector in operation, confronting the simulations and suppositions with reality, with this step completed, we could then confidently extrapolate to a real CTF3 scale system.

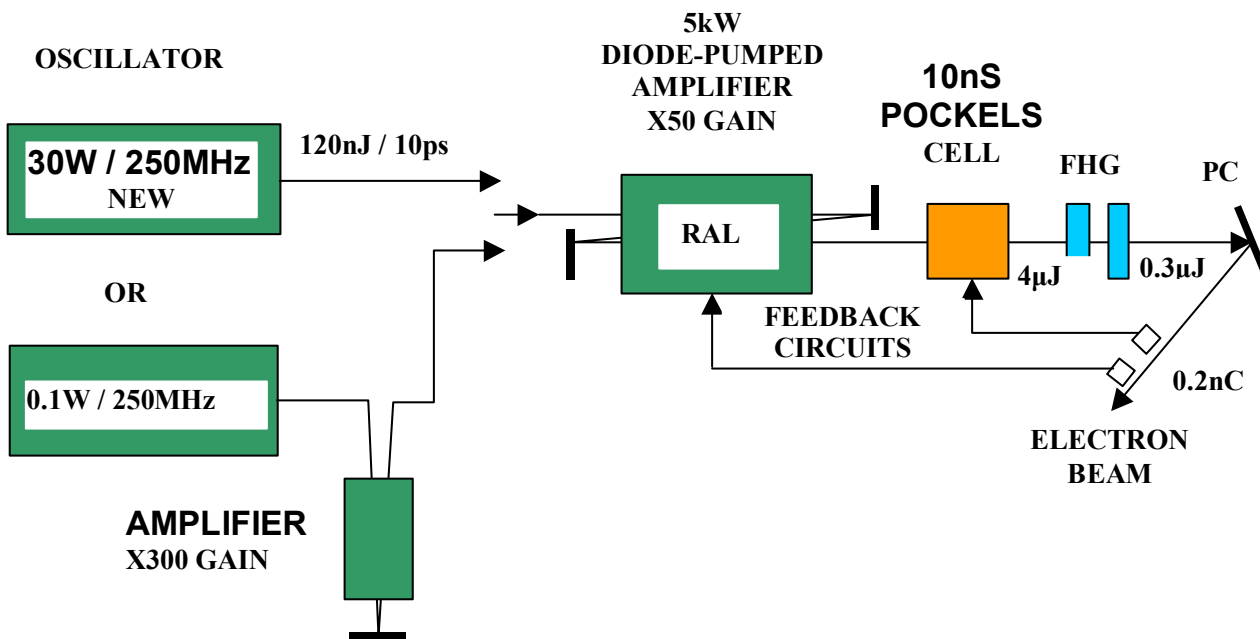

12-May-03
9:33:37

1
50 μ s
20.0 mV
-64.1 mV

M1
20 ns
100 mV
-320 mV

2
50 μ s
100 mV
-320 mV

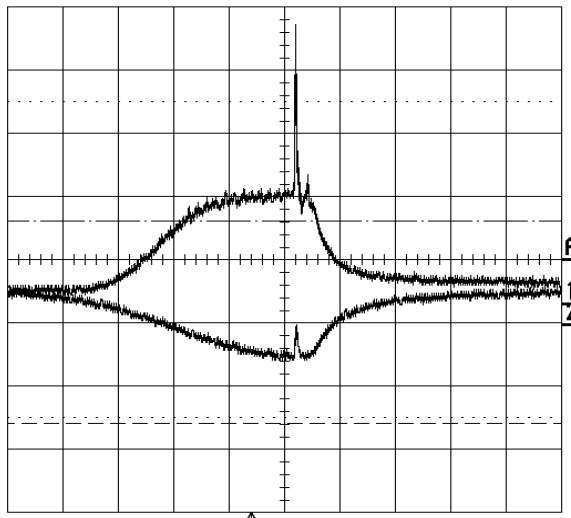

CHANNEL 1

Coupling
DC50 Ω
Grounded

V/div Offset
NORMAL
ECL TTL

Probe Atten
x1
x2
x5
x10
x20

50 μ s

1 20 mV 50 Ω

2 .1 V 50 Ω



Ext DC 500 mV 50 Ω

50 MS/s

NORMAL

Good amplifier performance: but note the amplitude ripples on the flat top of the pumping profile.

9-May-03
17:09:02

1
50 μ s
20.0 mV
-64.1 mV

M1
20 ns
100 mV
-320 mV

2
50 μ s
20.0 mV
-64.1 mV

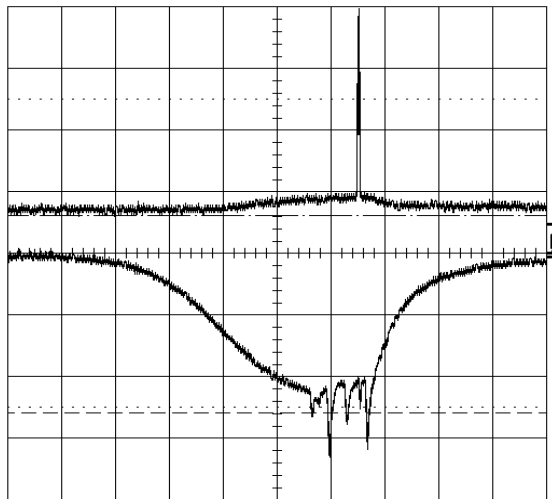

50 μ s

1 20 mV 50 Ω

2 20 mV 50 Ω



Ext DC 350 mV 50 Ω

50 MS/s

NORMAL

Optical feedback into the amplifier: oscillations occur at high gain, a laser cavity has been formed, one reflective surface was usually found to be the lens before the Harmonic generators or the beam dump after them, the other end of the cavity is impossible to find.

Given the available equipment and budget, the target performance was established:

Target Parameters	Units	Worst case	Nom.	Best case
Charge / pulse	nC	0.072	0.15	0.36
Number of pulses	-	350		
Distance between pulses	ns	4		
Macro-pulse width	μ s	1.4		
QE_{min}	%	4	5	6
Wavelength	nm	262		
$W_{cathode}$ / pulse	nJ	18	30	60
Optical path transm.	%	50		
IR/UV conversion eff.	%	3	5	10
Stabilization transm.	%	80		
W_{OUT} / pulse (Amplifier)	nJ	1500		
Total Amplifier Gain	-	$\leq 6000x$		
W_{OUT} / pulse (oscillator)	nJ	0.4		

This was assuming either a high-power oscillator or a separate pre-amplifier, neither of which materialised. In order to compensate, the RAL amplifier was set to a 5-pass mode, where operation in saturated gain mode would be harder to achieve, ($G \sim 5.7$, 5 times).

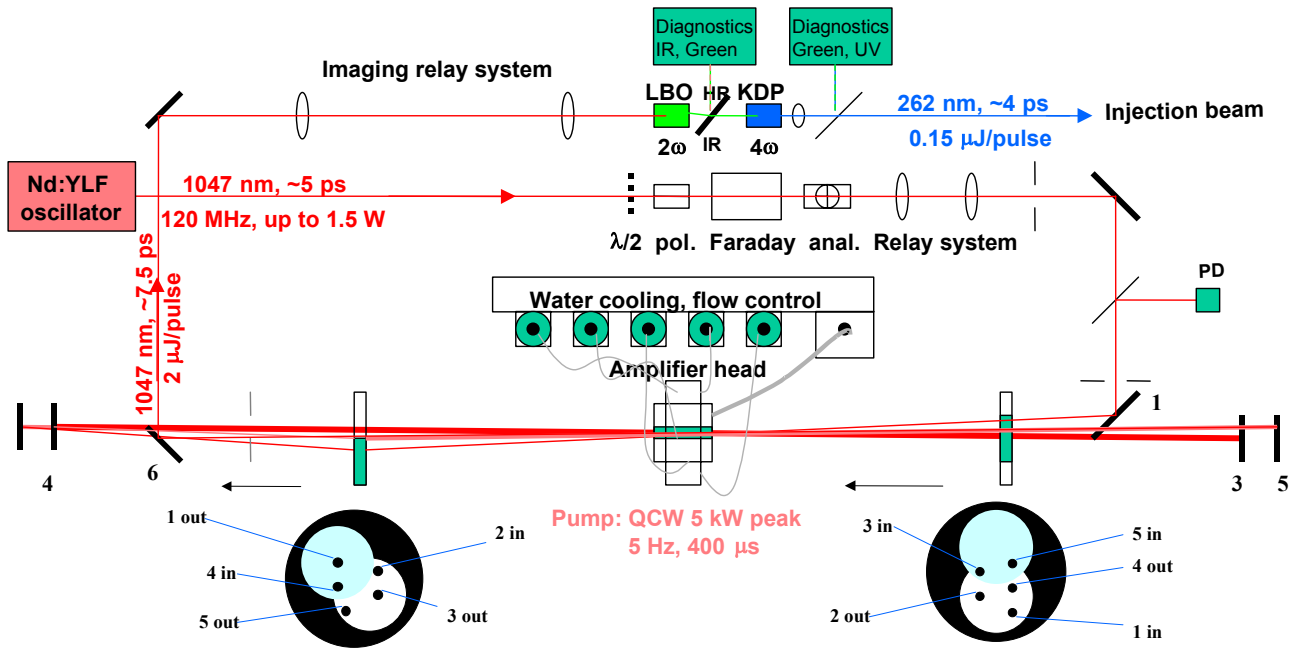

1.2us pulse train

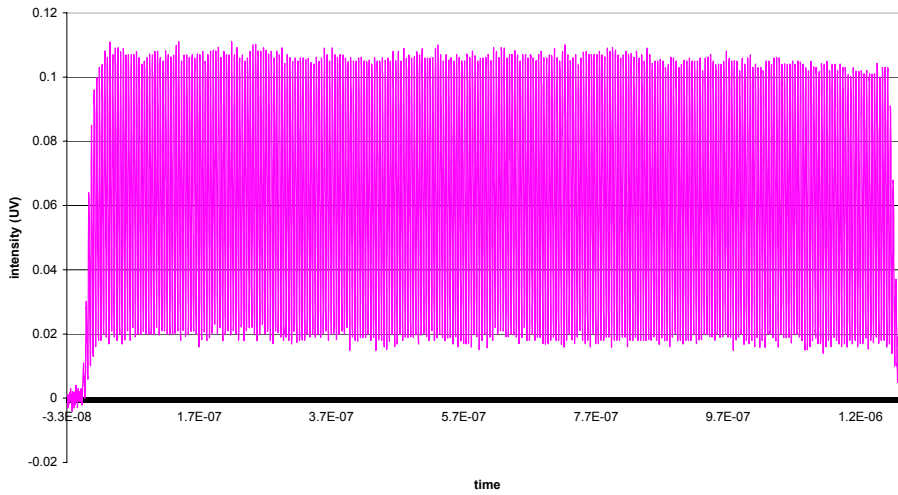

Start of train, bandwidth limited

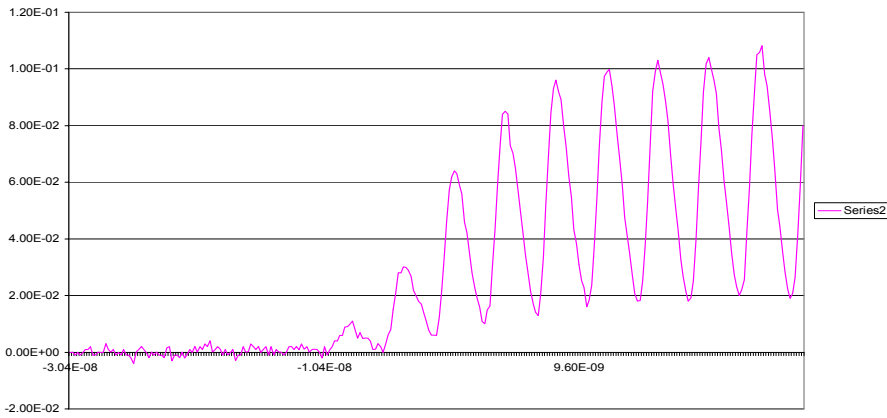

16-May-03
14:10:00

2
10 ns
0.50 V
-1.602 V

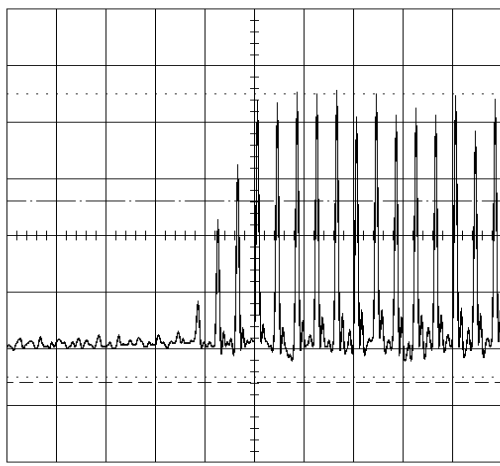

10 ns
1.5 V 50Ω
2.5 V 50Ω

Ext DC 180mV 50Ω

TRIGGER SETUP

Edge SMART

trigger on
1 2 Ext Ext10
Line

cp1g Ext
DC

slope Ext
Pos Neg

External
Atten x1
DC50Ω

holdoff
- - -
OFF Time Evts

5 GS/s

□ NORMAL

	target	actual	
IR Energy/pulse	1.5uJ	1.2uJ	
UV Energy/pulse	60nJ	16.8nJ	
WCM Charge/pulse	150pC	70pC	
Stability	<1%	1.9% rms	

Why not better?

- **5–Pass amplification: Strong saturation not possible: more sensitivity to input variations**
- **Ditto: it is not possible to control the beam size through the 5 passes, beam size and position change with each pass in the amplifier.**
- **Damaged pump diodes, giving lower output and lower gain, non-uniform beam profile and therefore poor conversion.**
- **Damaged 2HG crystal, possible source of reflections back to amplifier, causing instabilities, and contributes to poor conversion efficiency.**
- **Oscillations on LWE output (1.5%rms) at 10uS period, not synchronised to RF. Switching off the Klystron reduced these by 50%, so some interference to the LWE unit is suspected, also influenced by mode locking setting.**

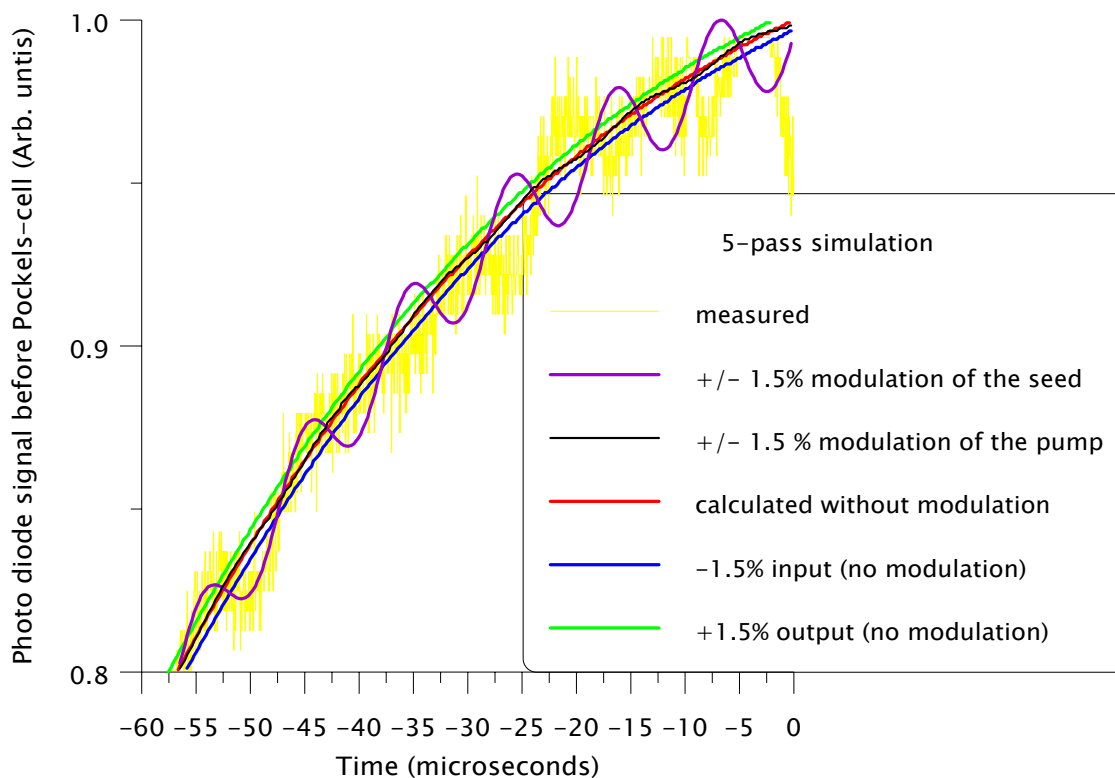

Another important advantage of a laser photoinjector for CTF3 is the possibility of phase coding using Pockels cells. A suitable HV pulse generator was purchased, and tests made on different Pockels cells.

Gsanger CPC5 BBO serial # 012, purchased 1996,
Transverse Pockels Cell, Aperture 4.8mm,
Dry cell for use at 262nm (AR coatings on windows and crystal),
L/2 voltage(262) = 2.8kV

n.b. L/2 in double pass at 630nm (test conditions) = 3.35kV, beyond stable range of HV pulser, 100% transmission cannot be achieved in these tests.

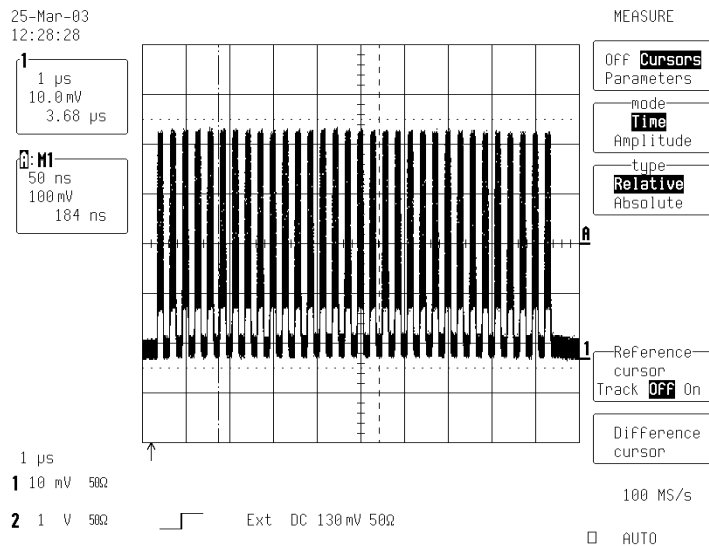
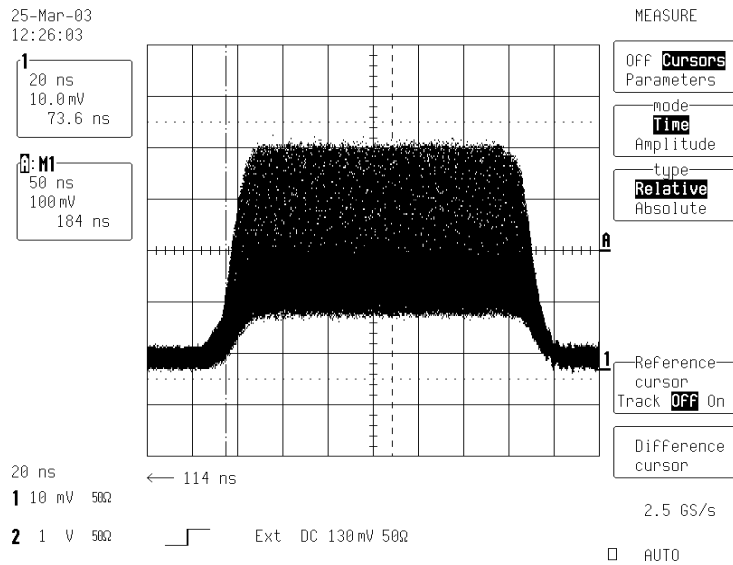

25-Mar-03
12:29:07

1
2 μs
10.0 mV
7.36 μs

M1
50 ns
100 mV
184 ns

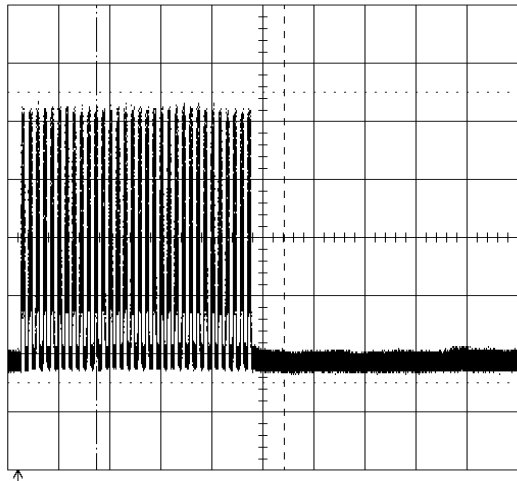

MEASURE

OFF **Cursors**
Parameters

mode
Time
Amplitude

type
Relative
Absolute

Reference
cursor
Track **OFF** On

Difference
cursor

2 μs
1 10 mV 50 Ω

2 1 V 50 Ω Ext DC 130 mV 50 Ω

100 MS/s

AUTO

No ringing after train

25-Mar-03
12:30:14

1
1 μs
2.00 mV
3.68 μs

M1
50 ns
100 mV
184 ns

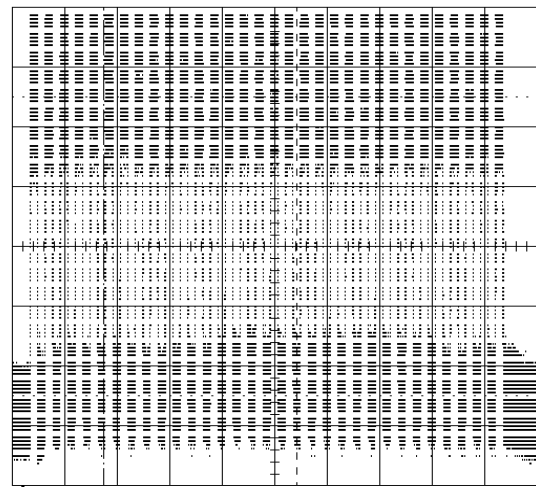

MEASURE

OFF **Cursors**
Parameters

mode
Time
Amplitude

type
Relative
Absolute

Reference
cursor
Track **OFF** On

Difference
cursor

1 μs
1 2 mV 50 Ω

2 1 V 50 Ω Ext DC 130 mV 50 Ω

100 MS/s

AUTO

expanded scale: near-constant baseline $\sim 1\text{mV}/43\text{mV}$

25-Mar-03
12:31:54

PERSISTENCE

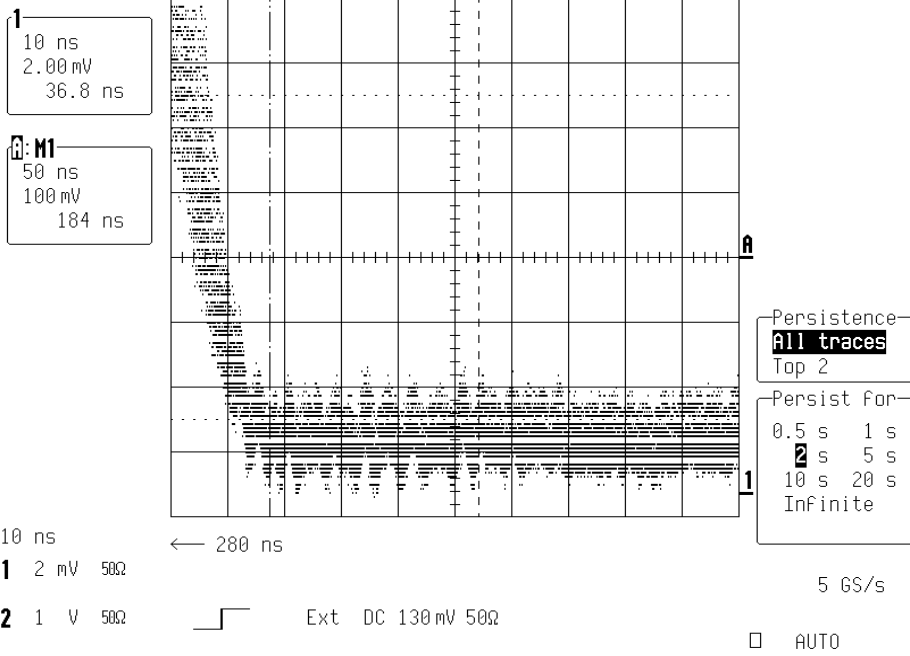

Detail: end of first pulse; high frequency ringing, ~350MHz

25-Mar-03
12:33:14

PERSISTENCE

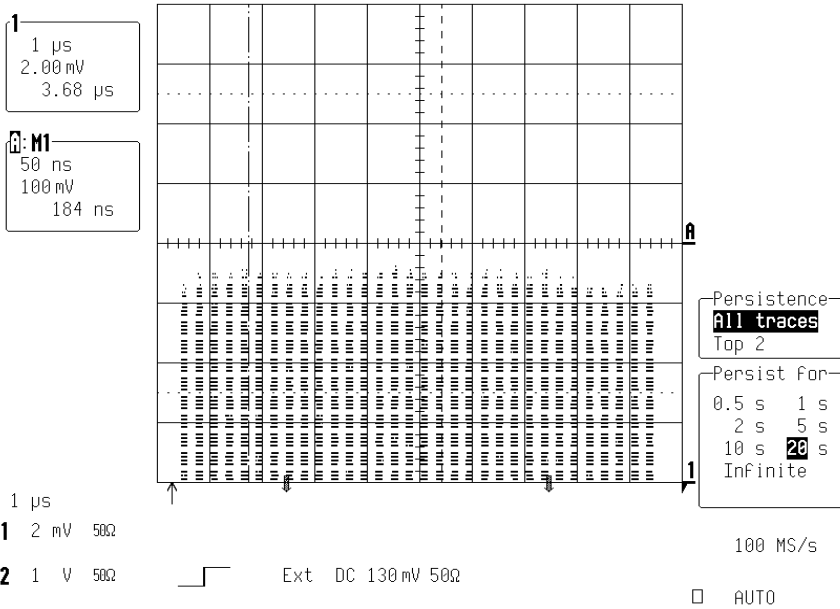

Expanded scale, pulse transmitted intensity, <1mV, 2.5%
(should improve if I/4 voltage could be used)

Gsanger (LINOS) LM8 IM serial #1780

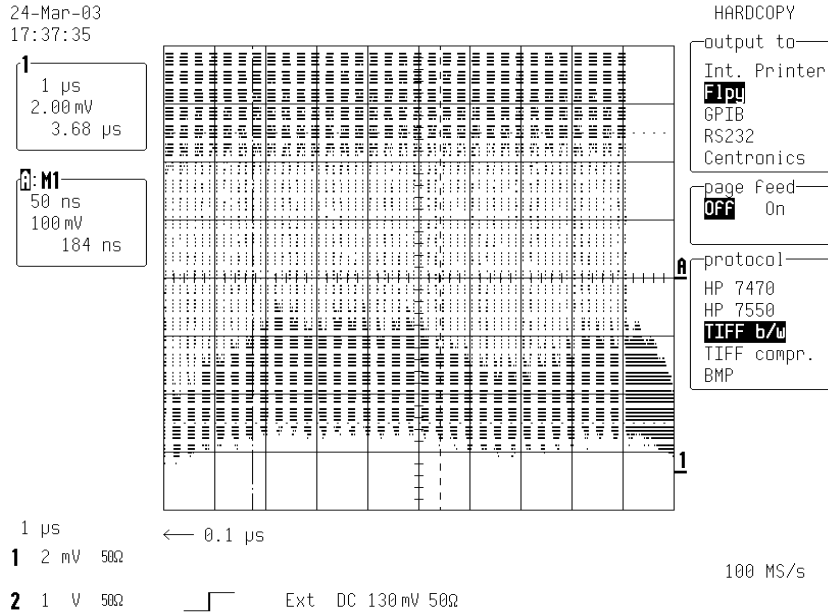

Train “off” transmission varies due to mechanical ringing causing polarisation changes, 4mV/35mV 11% error

“On “transmission changes due to crystal vibrations 2mV=6%

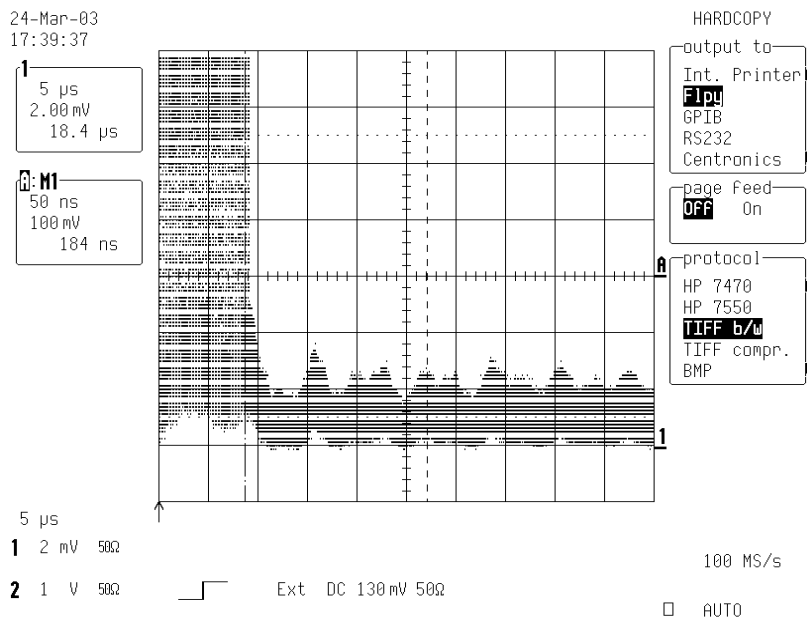

“ Off “ oscillations continue after last pulse, damped oscillation for 50us

Cleveland Crystal CX819 ser.# 0287

KD*P, longitudinal

For operation at 262nm, I/2 voltage= 3.5kV, Cap. 6pf

Calculated L/4(630nm)=4.2kV: cannot achieve best performance in HeNe tests (as pulser max. 2.9kV).

“Best performance” at 2.0kV, note this unit tested under non-optimum conditions, cell has smaller dimensions than can be accommodated in test housing, some EMC induced into measurement system. Provisional data:

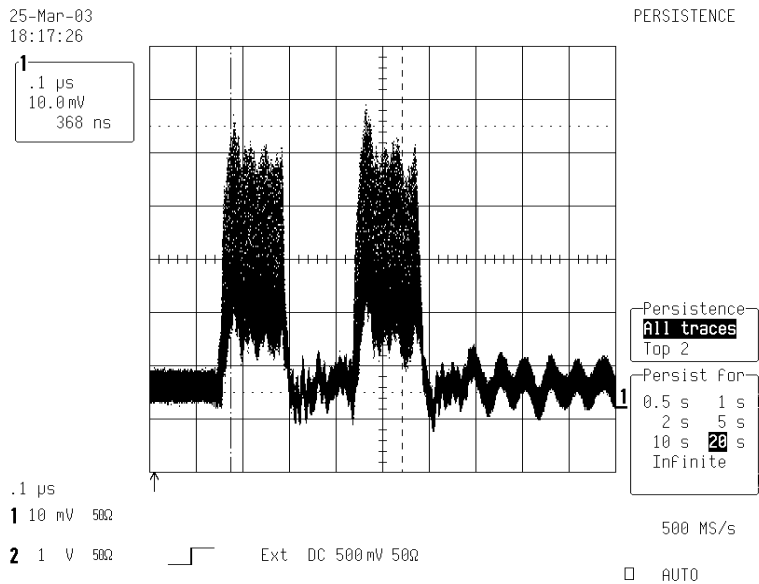
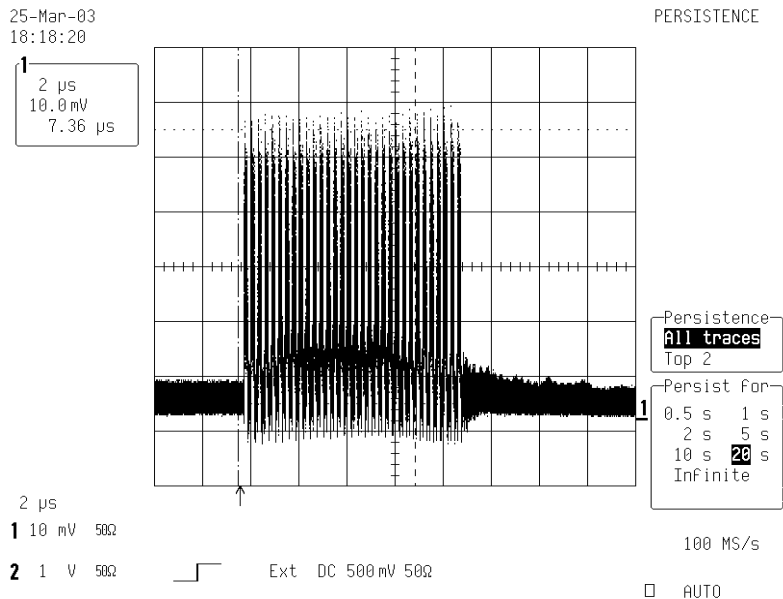

Conclusions

- ☹️ Our estimates of laser performance were out by x2, but for reasons that should not apply in CTF3 laser case.
- ☹️ The work was made much harder due to the lack of good instrumentation (detectors and scopes). Detector bandwidth limitations, low frequency cutoff, sensitivity and oscilloscope aliasing and sampling effects mask real artefacts. This will be far worse with higher frequency operation.
- ☹️ We had already foreseen the need for inter-stage isolation and imaging; lack of budget, space and time encouraged us to take a shortcut, which lead to the predictable problems.
- ☹️ Harmonic generation had not been thoroughly tested at RAL, much more space was required on the table than could be provided.
- 😊 A 1.2us, 300 pulse-train was generated, the laser system was capable of producing a 150us train.
- 😊 Pockels cells were used to effectively suppress leading pulses to better than 1% and to minimise the heating effects in the Harmonic generator crystals, which is essential for good control of the conversion efficiency.
- 😊 Pockels cells have also demonstrated the ability to perform the CTF3 phase-coding with 20ns rise and fall times, with 2% residual signal, due to acoustic vibrations. This performance should be improved in collaboration with the manufacturers.
- 😊 *The PILoT test has shown that if care is taken to include all of the elements isolation between stages, relay imaging and correction of astigmatism in the amplifiers, the predicted performance is attainable, and that it is reasonable to extrapolate from this test to a CTF3 scale system.*